

18000
2016 2 25-26

2.6

2.7

2.8

2.9

2.10

3-1

3-2

3-1

				t/a
1			ZSEJ90-2	10000
2			DWPI-5035	1800
			DWPI-8035	4200
3			W-0596/W-0597/W-0598	2000
4				18000

3.2.3

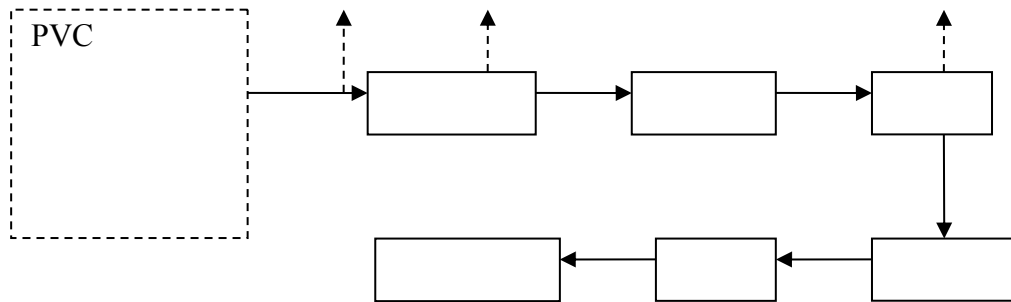

4.1



4.2

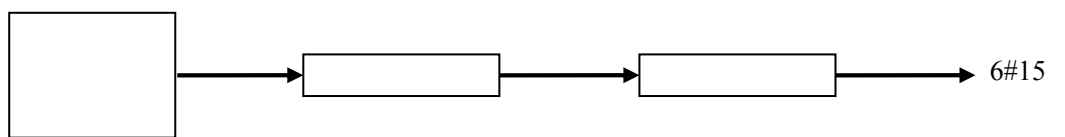
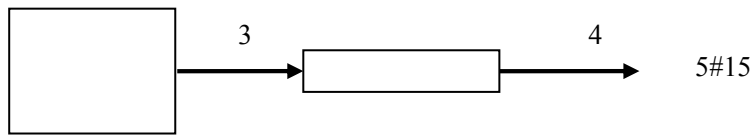
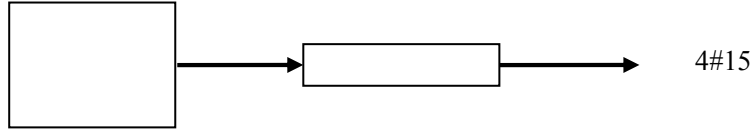
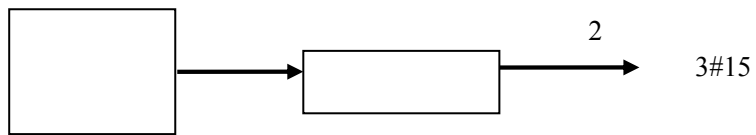
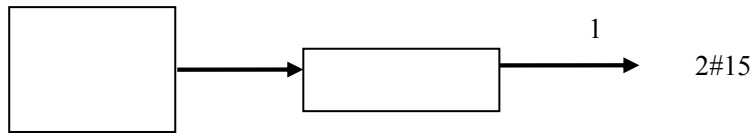
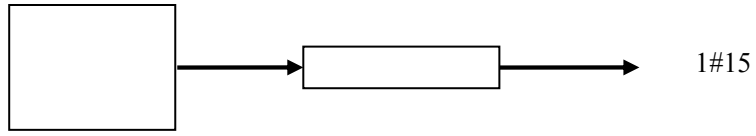

1# 4# 6#

18000

18000

15m

15m

6-1

6-2

			GB12348-2008 3

1

4

2

1

2

3

4

8()

2

4

pH

9-1

9-1

1							

GB16297-1996 2

GB16297-1996 2

GB16297-1996 2

9-2 9-6

GB12348-2008 3

9-7

9-7

9-8

9-8

		pH
	3	GB12348-2008 3

		<p style="text-align: right;">GB16297-1996</p> <p style="text-align: center;">2</p> <p style="text-align: right;">GB16297-1996 2</p> <p style="text-align: left;">GB16297-1996 2</p>
		9-9
	50	50
		9-8

12.1.1

2016 2 25-26

8()

12.1.2

pH

12.1.3

GB16297-1996 2

GB16297-1996 2

GB16297-1996 2

12.1.4

GB12348-2008 3

12.1.5

300

TVOCTVOC

,

9-9

12.2

